

Application Guide

A solid orange horizontal bar located below the title.

vehicle
identification



people
identification



Revolutionize Your Security

Nedap is the leading specialist in systems for long-range identification, wireless vehicle detection and city access control. We focus on identifying people and their vehicles without delaying them. This is how we empower security, parking and traffic management systems all over the world. Millions of professionals trust Nedap technology to support them, whether that is to access buildings, to drive into secured perimeters, or to find a parking spot. By combining cutting-edge technology with decades of experience, that is how we secure the flow of vehicles and people.

90+ years
as an establishment

30+ years
experience in RFID

HQ
based in Groenlo, Netherlands

Seven
offices worldwide



TRANSIT



LPR Lumo



nedap
Ecosystem



uPASS Target



uPASS Reach



Surface Lot & Garage Parking

Using Passive uPASS UHF Technology

Cost Effective Solution:

- Absolute best value for high volume. Easy to implement, compatible with existing access control systems.

Automated Vehicle Identification for Parking Access:

- Parking garages
- Parking lots
- Gated areas

Enhances User Experience by Offering Long Read Range:

- uPASS Target: Hands free access - up to 50 feet (33 ft. optimal)
- uPASS Reach: Multi-lane applications - up to 23 feet (16 ft. optimal)

Extensive Portfolio of Tags for Every Situation:

- Hang Tags
- WindshieldSticker Tags - interior and exterior
- Exterior Heavy Duty Tag
- UHF cards

uPASS Target - up to 50 ft.

uPASS Reach - up to 23 ft.

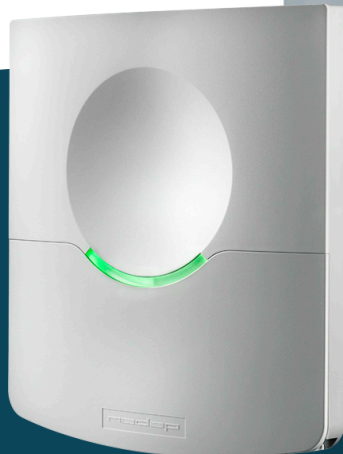

Surface Lot & Garage Parking

Passive Solutions By Nedap



Mounting Accessories:

Wall mount comes in the box with reader.



9217371 uPASS Target Reader

9218335 uPASS Target Weather Hood

5626595 uPASS Target Pole Mount Kit



Reader angled down and across 45 degrees.

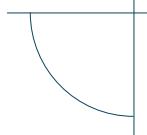

Best practice is to mount the reader 4-6 ft. above the highest tag placement.

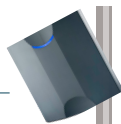

8.5 - 10 ft.

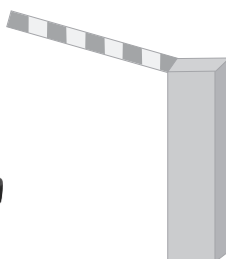
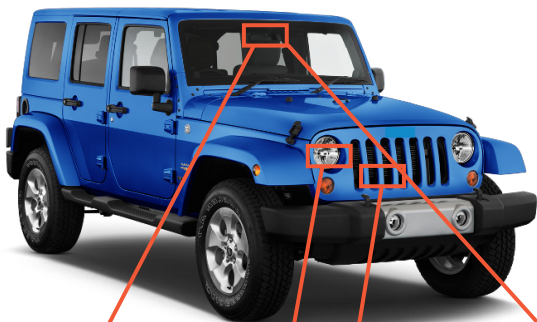

New Product!

Windshield Sticker Tags

- Cost Effective
- Long Range (Passive)
- Inside Application
- Special Order Tags Available



External Tags

- Metalized Content Workaround
- Exterior Mounted Sticker Tag
- Heavy Duty



Hang Tags

- Moveable
- Visitor Management
- Campus Parking
- Customization Available



Cards

- ISO & Combi Options
- Moveable
- Dual Technology in a Single Credential



Why Customize?

What Are You Waiting For?



- Brand Visibility
- Personalized
- Enhanced Security
- Streamlined Operations
- Professional Image
- Improved Experience
- Hang Tags
- Sticker Tags



Customization Made Easy

Your Business, Your Logo, Your Narrative

Login

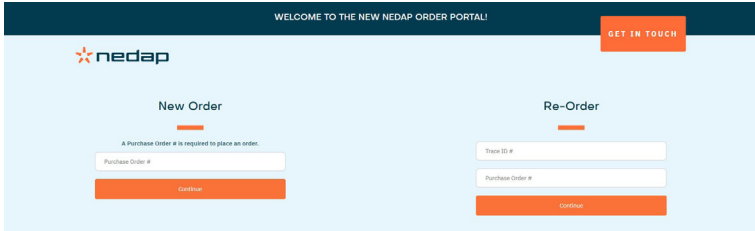

Upload

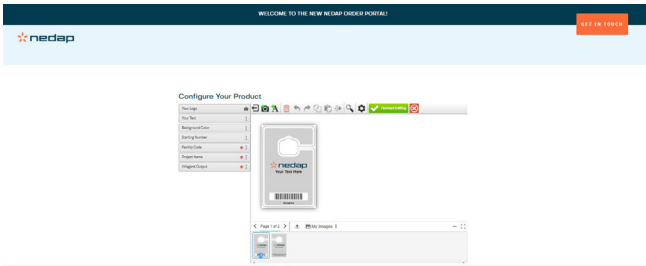

Design

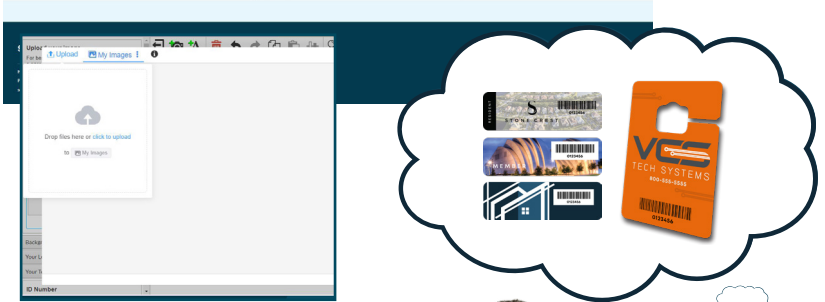

What You've Been Waiting For!

Revolutionize Your Business starting at the gate by creating customized Nedap RFID hangtags and sticker tags tailored with your narrative.

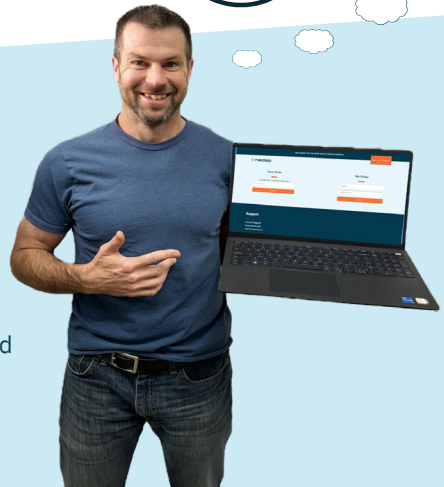

Emergency Vehicles & Industrial Equipment

Using Active TRANSIT RFID Technology

Vehicle Identification that Exceeds All Expectations:

- Absolute best solution for large industrial sized vehicles
- Recognition at speeds up to 125mph
- Easy to implement
- Compatible with existing access control systems

Simultaneous Vehicle and Driver Identification:

- Booster technology allows for both vehicle and driver IDs (Dual Authentication)

Automated Vehicle Identification for Secure Access:

- Performs well under harsh environmental conditions
- Robust 2.45GHz signal

Enhances User Experience by Offering Long Read Range:

- Hands free access - up to 50 feet (33 ft. optimal)

Extensive Portfolio of Tags for Every Situation:

- Window Button
- Window Button with switch
- Prox or Smartcard Booster
- End2End Booster
- Exterior Heavy Duty Tag
- Compact Tag



Municipalities

Active Solutions by Nedap



Mounting Accessories:

Wall mount comes in the box with reader.



9215689 TRANSIT Ultimate Reader

9218327 TRANSIT Ultimate Weather Hood

5626595 TRANSIT Ultimate Pole Mount Kit



Reader angled down and across 45 degrees.

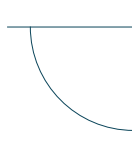

Best practice is to mount the reader 4-6 ft. above the highest tag placement.

8.5 - 10 ft.

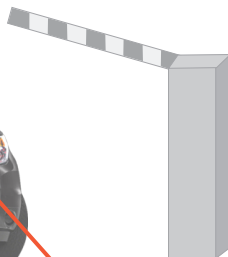
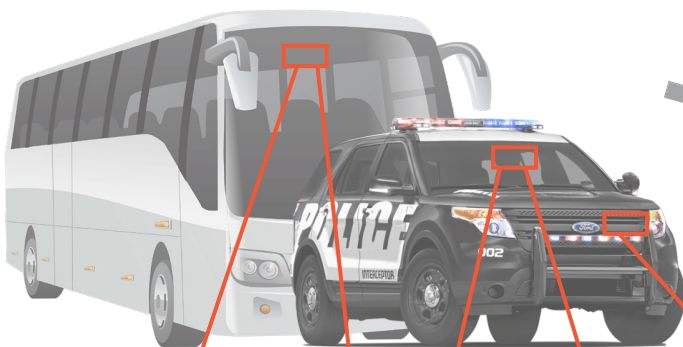

Window Buttons

- Always on or Button Activation Options
- up to 40 ft. read range
- up to 10 year lithium ion battery life



Prox & Smartcard Boosters

- Dual ID or Single ID options (Prox Boosters)
- up to 40 ft. read range
- AAA battery powered
- Smartcard Boosters read a portion of CSN



End2End Booster

- Supports HID SEOS, iCLASS, Elite Keys, SEOS Mobile ID (Android only)
- up to 33 ft. read range
- Existing Applications Upgradeable with Tab Board Purchase



Exterior Heavy Duty Tag

- Exterior Mount
- up to 60 ft. read range
- ATEX Rated
- Mountable directly to metal
- up to 10 year lithium ion battery life



Visitor Management & Secondary Parking Access

Using LPR Technology



All-In-One License Plate Camera:

- No additional software required
- Easy to implement
- Can be used as a stand alone or is compatible with existing access control systems
- Supports industry-standard communication systems

Back-up Parking Access:

- LPR is used to back-up existing RFID systems
- Can be used for dual authentication

Enhances User Experience:

- Barrier-controlled and free-flow applications
- Uses plates for credential
- 8 to 33 feet read range
- Identification speeds up to 100mph
- Tamper notifications available

Gateless Parking Access:

- Visitor management
- Detects vehicle direction



Convenient Parking

Nedap LPR LUMO Solution



Mounting Accessories:

Reader comes with pole mounting kit.



9986138 LUMO Reader

Reader should not be angled more than 25 degrees up and down or side to side.



Ideal installation placement for the LUMO is at bumper height (2 ft. height) about 6-9 ft. behind the barrier.

Max Height: 14 ft.

Optimal Read Zone 8 – 33 ft.



With states that don't require the front plate, you can set the reader to point at the back of the vehicle, but you have to have enough of a lane to get the read between 8 and 33 ft. for detection.

Application Note

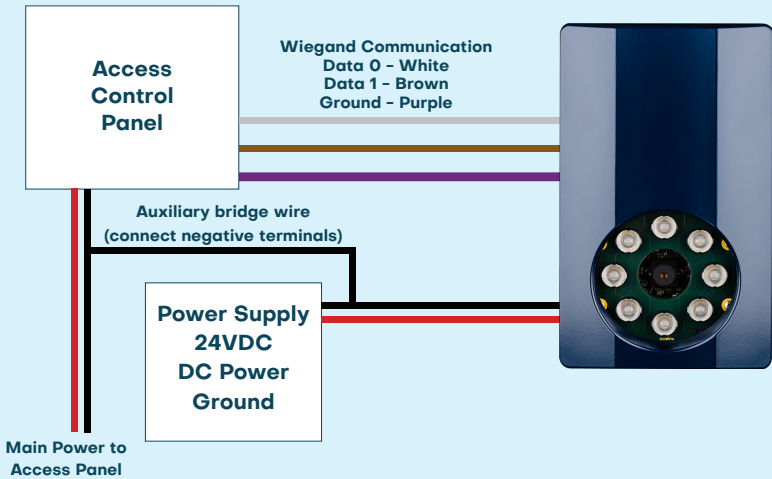
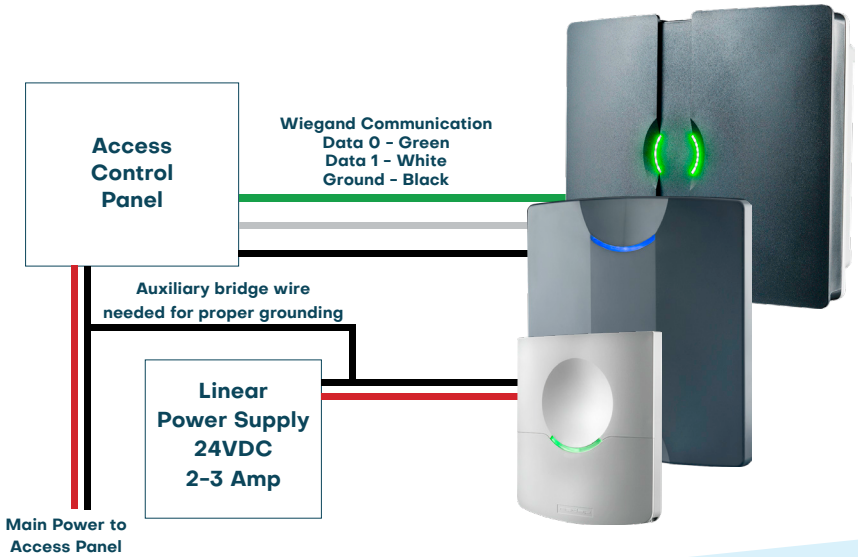
TRANSIT, uPASS, and LUMO Grounding



Product Verticals

Applications	Product Line		
	uPASS (900MHZ)	TRANSIT (2.45 GHZ)	LUMO
Military		● ●	
Airport	●	● ●	
Government	●	● ●	
Parking	● ●	● ●	● ●
Industrial	●	● ●	●
High-End Vehicles	●	● ●	● ●
Transportation & Logistics	●	● ●	●
Mining		● ●	
HOA/Gated Community	● ●	●	● ●
Education	● ●	●	●
Healthcare	● ●	●	●
Condominiums	● ●	●	● ●
Multi-Tenant	● ●	●	● ●
People/Door Access	●	●	
Arenas	● ●		●
Car Wash	● ●		●
 Commonly used vertical fits for Nedap products  Go to Product Line	Tag Type: Passive	Tag Type: Semi-Active	Tag Type: License Plate

Projects to Note

Utility Companies

Marathon Petroleum Canton, OH
 Kansas City Power & Light
 Dominion Energy Richmond, VA

Sport Venues

Lucas Oil Stadium (Indianapolis Colts)
 WWE Corporate Facility
 Gillette Stadium (New England Patriots)

Transportation

Alaska Department of Transportation
 Des Moines (IA) Transit Bus System
 Oregon Department of Transportation

Airports

Ottawa International Airport
 Cincinnati Airport
 Taxi Management (LAX)

Corporate Facilities

ESPN, Inc Headquarters
 Bill Gates Foundation
 Toyota Manufacturing

Education

Duke University Parking Facilities
 Stanford University
 Yale University Enforcement

Government & Military

Department of Homeland Security (Buffalo, NY)
 Fort Bragg Military Facility (Fayetteville, NC)
 Kansas City IRS Entrance
 Alaska DOT

Casinos/Luxury Residential

Palace Casino (Las Vegas, NV)
 Panorama Towers (Las Vegas, NV)
 Oklahoma City

Commercial Complex

Eaton Center (Toronto) - Largest TRANSIT Project in the World



Serving our Client Nedap in the Americas

Contact Info

Phone: 417-339-7368

Press 1 for Shipping Department

Press 2 for Sales Department

Press 3 for Technical Assistance

Purchasing

You can obtain pricing from our Distribution Partners.

(List available upon request.)

If you have direct pricing, POs must be submitted through: orders-ids-us@nedap.com

- All items ship out of Chicago area.
- Normal Stock items have a normal lead time of 3-4 days.
- Special Order items have a lead time of 4-6 weeks once all proper information is received.

☆ **Tracking Information:**

For tracking or status of a PO, please email with PO # in subject line to: orders-ids-us@nedap.com

Schedule a Training

Scan the QR Code and Help us Tailor a Training to Fit Your Needs

Discovery Sessions

- Who Is Nedap?
- The Nedap RFID Ecosystem
- Installation Best Practices
- Broad Sales & Technical Training
- Nedap, A Perfect Fit For Your Business
- Live Personalized Virtual Training



Deep Dive Sessions

- Follows A Discovery Session
- Project Specific Support
- Additional Large Project Guidance



Scan Here to Schedule a Discovery Session and find out how we can help grow your Business with Nedap!



Thank You



Need more information? Check our portal.
Scan the QR Code.